

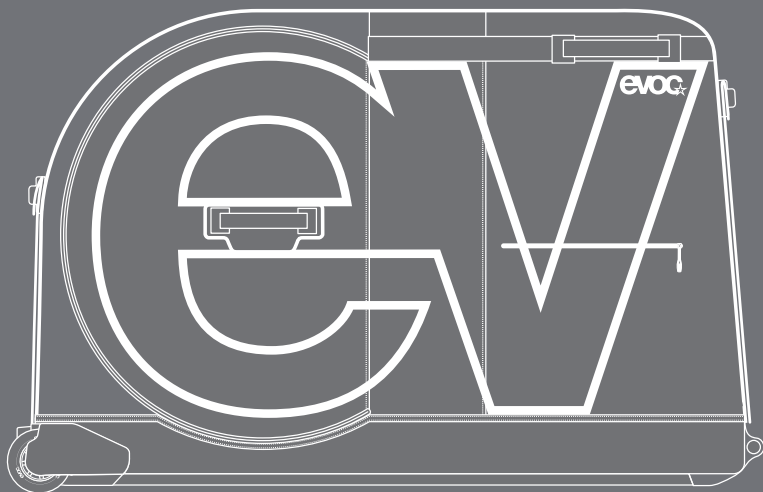

INSTRUCTION MANUAL FOR PACKING
A MOUNTAINBIKE OR ROADBIKE IN
YOUR **BIKE TRAVEL BAG PRO**



TOOLS NEEDED



PEDAL WRENCH



ALLEN KEY

ENCLOSED PARTS

4x WHEELCASE TUBES



2x FRONT STICKS (A)



2x REAR STICKS (B)



1x BIKE BLOCK



2x WEBBING LOOPS



1x FRAME PAD



1x FORK PADDING



1x ROAD BIKE ADAPTER



1x CLIP-ON WHEEL



BIKE TRAVEL BAG PRO

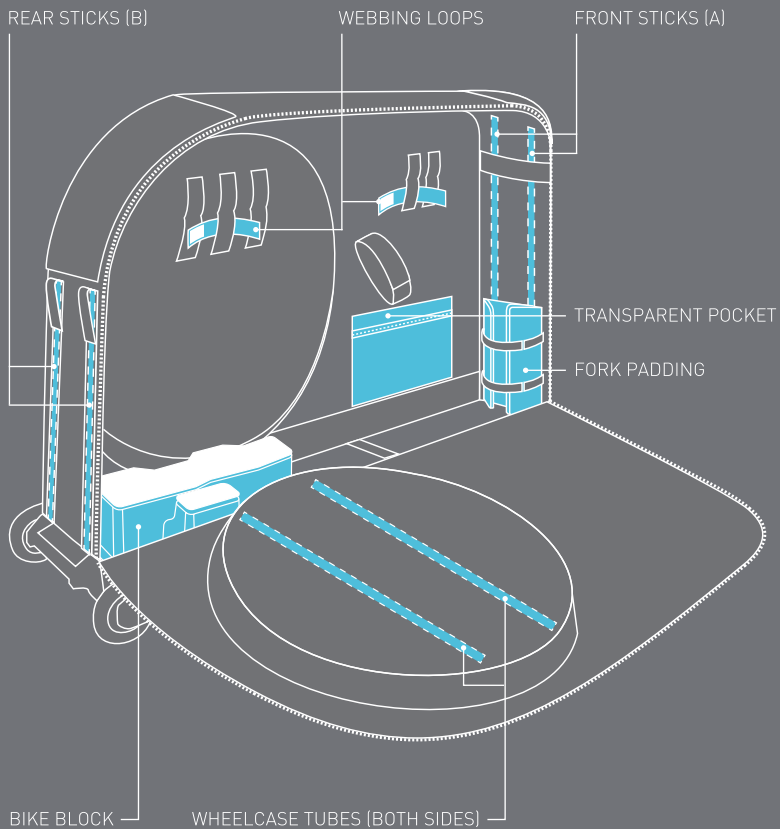

HOW TO ASSEMBLE YOUR BIKE TRAVEL BAG PRO

// 01

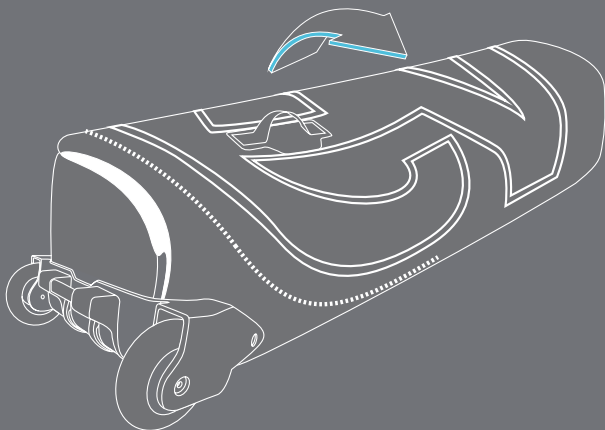

// 02

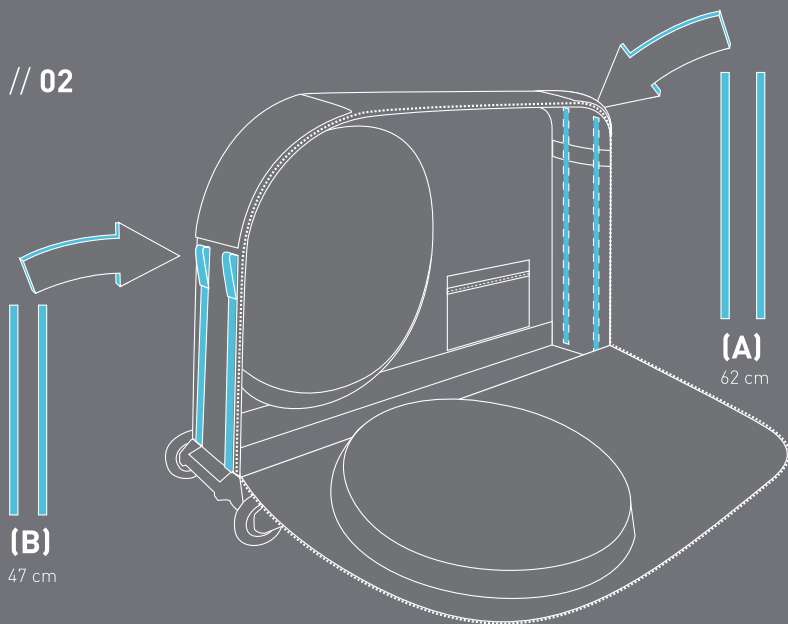

// 03

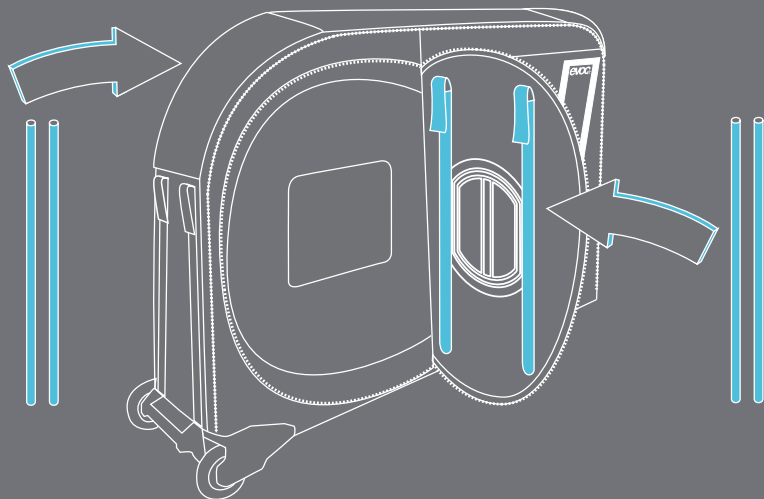

// 04

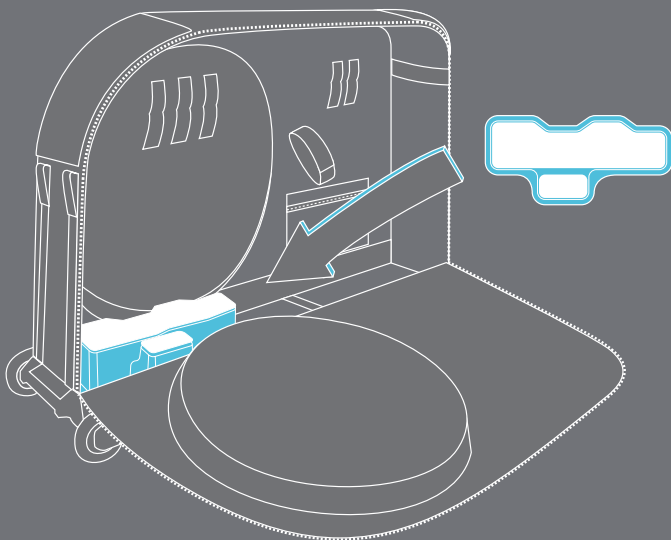

// 05

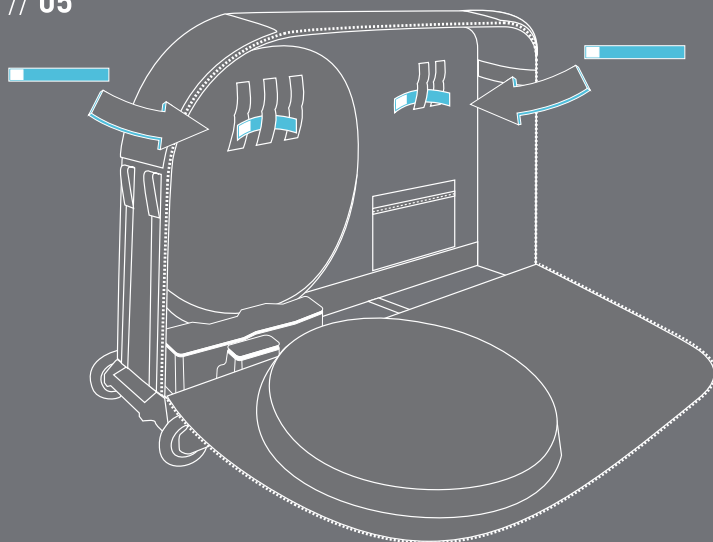

// 06

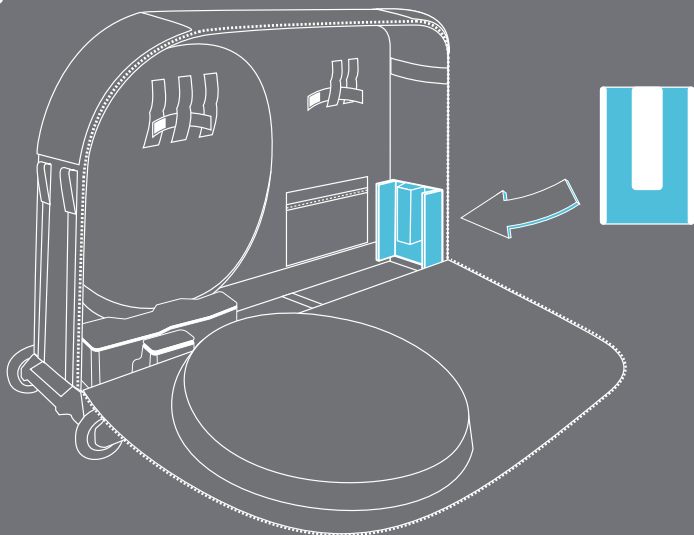

HOW TO STORE YOUR MOUNTAINBIKE (FOR ROAD BIKE GO TO // 19)

// 07



Add FRAME PAD

// 08

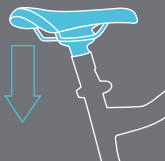

Lower in your bicycle saddle

// 09

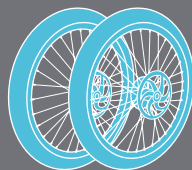

Remove both wheels

// 10



Remove both pedals

// 11

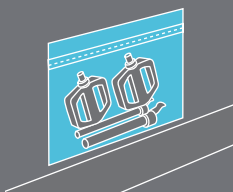

Put quick release and pedals
in transparent pocket

// 12

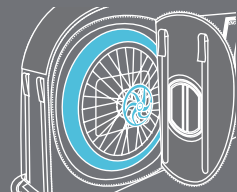

Put wheels in side pockets
Disc facing outwards!

// 13



Remove handle bar and fix it on FRAME PAD



// 14

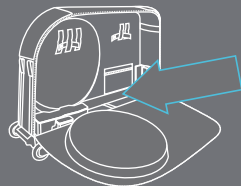

Place your bike in the
BIKE TRAVEL BAG PRO

// 15

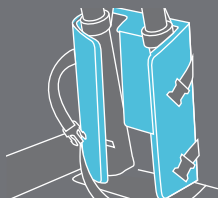

Put fork into
FORK PADDING

// 16

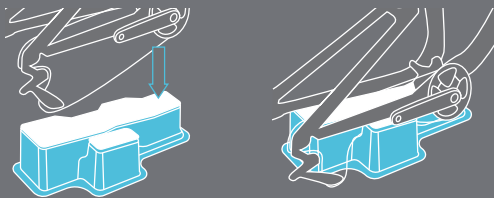

Position bottom bracket on BIKE BLOCK

// 17

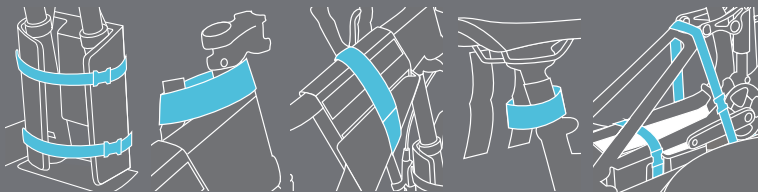

Fix your bike with red straps

// 18

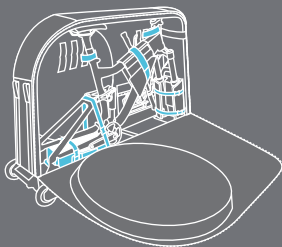

Looks like this? Well done.

HOW TO STORE YOUR ROADBIKE

// 19

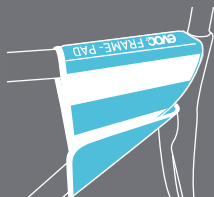

Add FRAME PAD

// 20

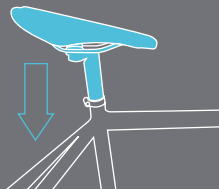

Lower in your bicycle saddle

// 21

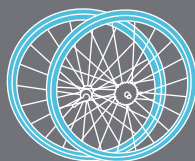

Remove both wheels

// 22



Remove both pedals

// 23

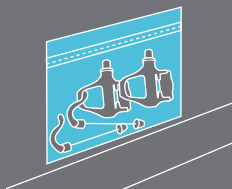

Put quick release and pedals
in transparent pocket

// 24

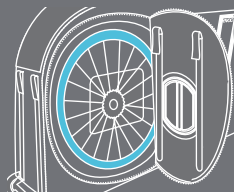

Put wheels in side pockets

// 25

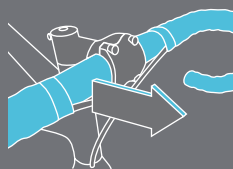

Remove handle bar and fix it on FRAME PAD

// 26

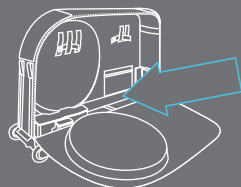

Place your bike in the
BIKE TRAVEL BAG PRO

// 27

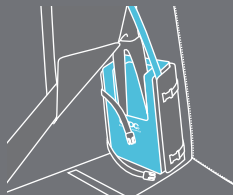

Put fork into ROAD BIKE ADAPTER and both into FORK PADDING

// 28

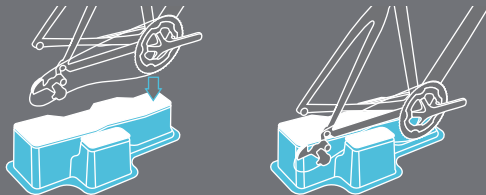

Position bottom bracket on BIKE BLOCK

// 29



Fix your bike with red straps

// 30

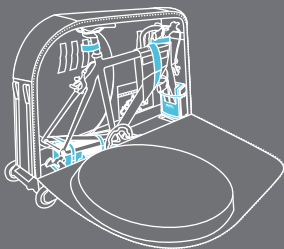

Looks like this? Well done.

HOW TO USE THE CLIP-ON WHEEL

// 31

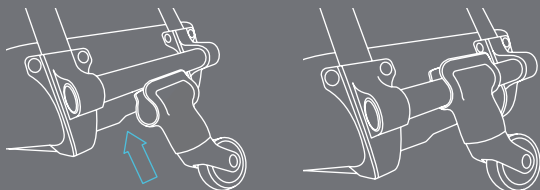

Click CLIP-ON WHEEL to ALUMINIUM FRONT HANDLE SYSTEM. Pins have to go into feed holes!

// 32



Remove CLIP-ON WHEEL before luggage drop and put back into BIKE TRAVEL BAG PRO

WARRANTY AND AFTER SALES SERVICE



WARRANTY

<http://www.evocsports.com/warranty>

SEPARATE AVAILABLE

ROAD BIKE ALUMINIUM STAND

Extra stability frame to fix your triathlon-/
roadbike into our BIKE TRAVEL BAG

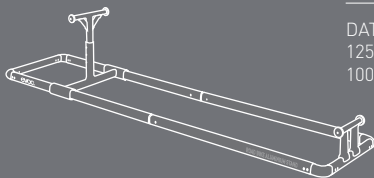

DATA
125 x 25 x 15cm /
1000 g

BLACK
5103 - 101

ROAD BIKE WHEEL CASE

Extra protection for road bike wheels -
fit perfectly into the wheel compartments
of our BIKE TRAVEL BAGS

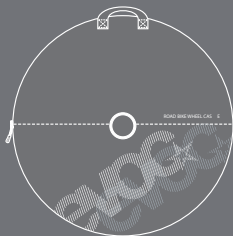

DATA
70 x 5 cm / 750 g

BLACK
3104 - 101

CHAIN COVER

Optimal protection from dirt and damage
caused by the bike chain.



DATA
60 x 30 cm / 120 g

BLACK
5108 - 101